



**Heating Systems Company**

A subsidiary of **BRADFORD WHITE** Corporation

# Double-Wall Indirect-Fired WATER HEATER

A Spanish language version of these instructions is available by contacting the manufacturer listed on the rating plate.  
La version española de estas instrucciones se puede obtener al escribirle a la fábrica cuyo nombre aparece en la placa de especificaciones.

## INSTALLATION/OPERATING MANUAL WITH PARTS LISTING AND TROUBLESHOOTING GUIDE



### **WARNING**

To avoid damage or injury, there must be no materials stored against the indirect water heater and proper care shall be taken to avoid unnecessary contact (especially by children) with the indirect water heater.

- Do NOT store or use gasoline or other flammable liquids in the vicinity of this water heater or any other appliance.



As required by the state of California Proposition 65.



*For your family's comfort, safety, and convenience, we recommend this water heater be installed and serviced by a plumbing professional.*

## **CONGRATULATIONS!**

**You have purchased one of the finest water heaters on the market today!**

**This installation, operation, and instruction manual will explain in detail the installation and maintenance of your new Indirect water heater. We strongly recommend that you contact a plumbing professional for the installation of this water heater.**

**We require that you carefully read this manual, as well as the enclosed warranty, and refer to it if questions arise. If you have any specific questions concerning your warranty, please consult the plumbing professional from whom your water heater was purchased. For your records we recommend that you write the model, serial number and installation date of your water heater in the back of this manual.**

**This manual should be kept with the water heater.**

**We're committed to providing you with the finest water heater made.**

## **TABLE OF CONTENTS**

<b>I-</b>	<b>IMPORTANT INFORMATION.....</b>	<b>3</b>
<b>II-</b>	<b>SPECIFICATIONS.....</b>	<b>7</b>
<b>III-</b>	<b>GENERAL INFORMATION.....</b>	<b>10</b>
<b>IV-</b>	<b>PRE-INSTALLATION.....</b>	<b>12</b>
<b>V-</b>	<b>WATER CONNECTIONS.....</b>	<b>17</b>
<b>VI-</b>	<b>ELECTRICAL CONNECTIONS.....</b>	<b>22</b>
<b>VII-</b>	<b>OPERATING INSTRUCTIONS.....</b>	<b>25</b>
<b>VIII-</b>	<b>MAINTENANCE.....</b>	<b>28</b>
<b>IX-</b>	<b>TROUBLESHOOTING GUIDE.....</b>	<b>31</b>
<b>X-</b>	<b>PARTS LIST.....</b>	<b>33</b>
<b>XI-</b>	<b>NOTES.....</b>	<b>34</b>

 **CAUTION**

The maximum boiler water supply temperature to the indirect heat exchanger must not exceed 240°F (115°C).

**NOTICE**

Insulation blankets are not required for this water heater. This water heater meets or exceeds the ASHRAE/IES 90.1b standards with respect to insulation and standby loss requirements.

**SECTION I**  
**IMPORTANT INFORMATION**  
**-READ CAREFULLY-**

The equipment must be installed in accordance with those installation regulations required in the area where the installation is to be made. These regulations must be carefully followed in all cases. Authorities having jurisdiction shall be consulted before installations are made.

All wiring on water heaters installed in the USA must be in accordance with the National Electrical Code and/or local regulations; or in Canada, installed in accordance with the Canadian Electrical Code and/or local regulations.

The following terms are used throughout this manual to bring attention to the presence of hazards of various risk levels, or to important information concerning product life.

 **DANGER**

Indicates an imminently hazardous situation, which, if not avoided, will result in death, serious injury, or substantial property damage.

 **CAUTION**

Indicates a potentially hazardous situation, which, if not avoided, may result in moderate, or minor injury or property damage.

 **WARNING**

Indicates a potentially hazardous situation, which, if not avoided, could result in death, serious injury, or substantial property damage.

**NOTICE**

Indicates special instructions on installation, operation or maintenance, which are important but not related to personal injury hazards.

 **DANGER**

DO NOT store or use gasoline or other flammable, combustible, or corrosive vapors and/or liquids in the vicinity of this or any other appliance.

IF YOU SMELL GAS:

- DO NOT try to light any appliance.
- DO NOT touch any electric switch; DO NOT use any telephone in your building.
- Immediately call your gas supplier from a telephone in another building. Follow the gas supplier's instructions.
- If you cannot reach your gas supplier, call the fire department

**DO NOT OPERATE THE APPLIANCE UNTIL THE LEAKAGE IS CORRECTED!**

Liquefied petroleum gas/propane gas is heavier than air and will remain at floor level if there is a leak. Basements, crawl spaces, closets, and areas below ground level will serve as pockets for accumulation of leaking gas.

This water heater is supplied with an adjustable thermostat to control water temperature. Hot water temperatures required for automatic dishwasher and laundry use can cause scald burns resulting in serious personal injury and/or death. The temperature at which injury occurs varies with the person's age and the time of exposure. The slower response time of disabled persons increases the hazards to them. NEVER allow small children to use a hot water tap or to draw their own bath water. NEVER leave a child or disabled person unattended in a bathtub or shower.

To comply with NSF requirements this water heater is to be:

- a) Sealed to the floor with sealant, in a smooth and easily cleanable way, or
- b) Installed with an optional leg kit that includes legs and/or extensions that provide a minimum clearance of 6" beneath the water heater.

**⚠ WARNING**

**Installation is not complete unless a properly sized/capacity pressure and temperature relief valve is installed into the side of the water heater. See the General Information section of this manual for details.**

**This water heater contains very hot water under high pressure. DO NOT unscrew any pipe fittings or attempt to disconnect any components of this water heater without positively assuring the water is cool and has no pressure. Always wear protective clothing and equipment when installing, starting up, or servicing this water heater to prevent scald injuries. DO NOT rely on the pressure and temperature gauges to determine the temperature and pressure of the water heater. This water heater contains components that become very hot. DO NOT touch any components unless they are cool.**

**Improper installation, adjustments, alteration, service or maintenance can cause property damage, personal injury or loss of life. Failure to follow all instructions in the proper order can cause personal injury or death. Read and understand all instructions, including all those contained in component manufacturer's manuals, which are provided with the appliance before installing, starting-up, operating, maintaining, or servicing this appliance. Keep this manual and literature in legible condition and posted near the appliance for reference by owner and service technician.**

**This water heater requires regular maintenance and service to operate safely. Follow the instructions contained in this manual. Installation, maintenance, and service must be performed only by an experienced, skilled, and knowledgeable installer or service agency.**

**⚠ WARNING**

**It is the responsibility of the installing contractor to see that all controls are correctly installed and are operating properly when the installation is complete.**

**DO NOT operate the water heater with jumpered or absent controls or safety devices.**

**DO NOT tamper with or alter the water heater and/or controls.**

**DO NOT operate the water heater if any external part has been under water. Immediately call a qualified service technician to inspect the appliance and to replace any part of the control system that was under water.**

**This water heater is suitable for installation on combustibile flooring. DO NOT install this water heater on carpeting.**

**DO NOT operate this water heater without first being certain it is filled with water.**

**Flammable items, pressurized containers, or any other potential fire hazardous articles must never be placed on or adjacent to the heater. Containers of flammable gases should not be stored or used in the same room with this water heater.**

**Hydrogen gas can be produced in an operating water heater that has not had water drawn from the tank for a long period of time (generally two weeks or more). HYDROGEN GAS IS EXTREMELY FLAMMABLE. To prevent the possibility of injury under these conditions, we recommend that the water faucet be opened for several minutes at the kitchen sink before you use any electrical appliance that is connected to the hot water system. If hydrogen is present, there will be unusual sounds such as air escaping through the pipes as hot water begins to flow. DO NOT smoke or have open flame near the faucet at the time it is open.**

## SECTION II SPECIFICATIONS

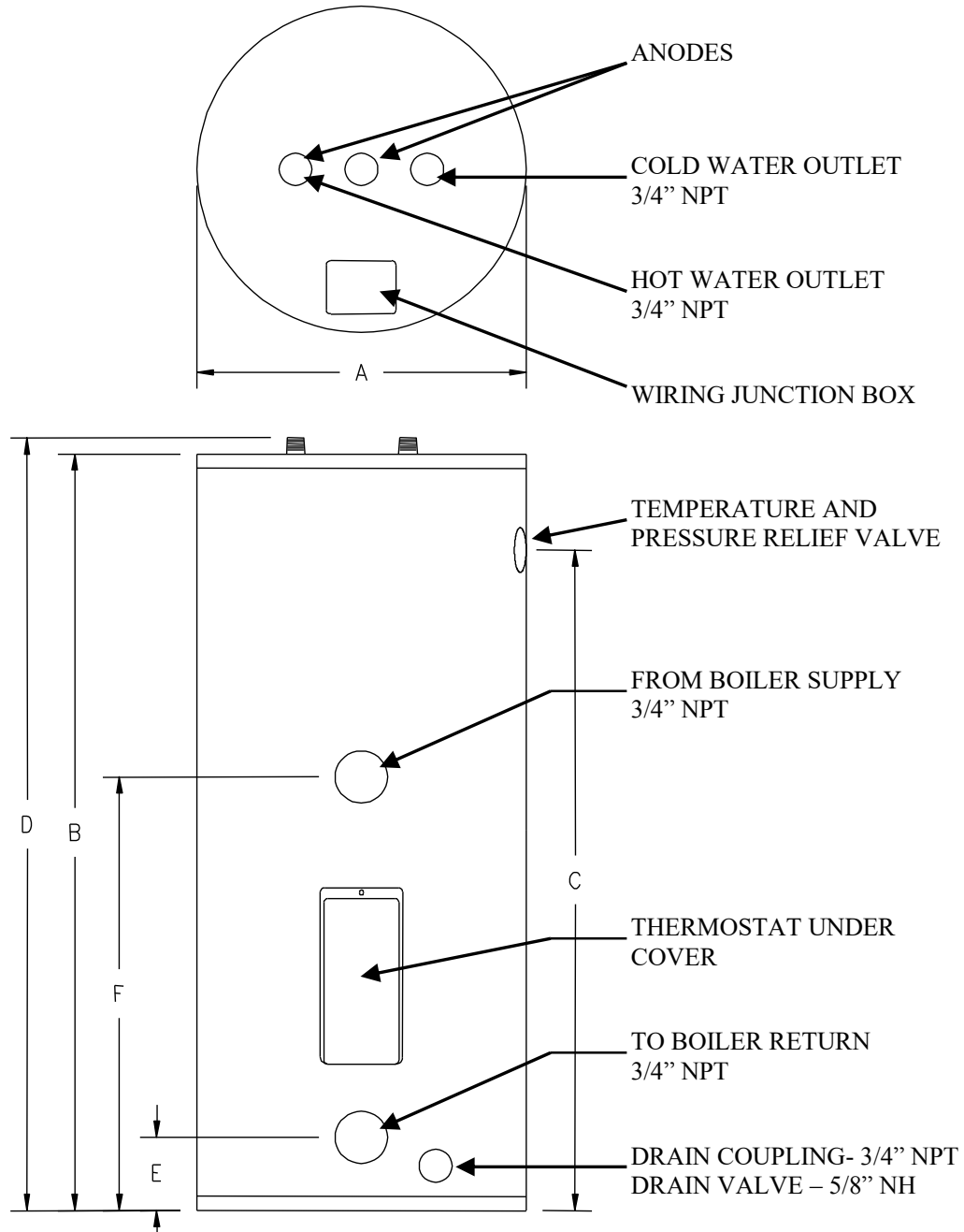

**Table 1: Water Heater Dimension (Inches)**

<b>Model</b>	<b>A</b>	<b>B</b>	<b>C</b>	<b>D</b>	<b>E</b>	<b>F</b>
<b>40-Gal.</b>	<b>22</b>	<b>41-1/8</b>	<b>34-3/8</b>	<b>41-7/8</b>	<b>5-3/8</b>	<b>27-1/2</b>
<b>50-Gal.</b>	<b>22</b>	<b>46-1/4</b>	<b>40-1/8</b>	<b>47</b>	<b>5-3/8</b>	<b>27-1/2</b>
<b>65-Gal.</b>	<b>22</b>	<b>59-1/4</b>	<b>53-1/8</b>	<b>60</b>	<b>5-3/8</b>	<b>27-1/2</b>
<b>80-Gal.</b>	<b>24</b>	<b>59</b>	<b>52-7/8</b>	<b>59-3/4</b>	<b>5-3/8</b>	<b>27-1/2</b>

Specifications continued-

**Table 2: Water Heater Capacities**

Model	Tank Capacity (Gal)	Coil Volume (Gal)	Dry Weight (Lbs)	Wet Weight (Lbs)
40-Gal.	37	2.5	170	470
50-Gal.	43	2.5	180	547
65-Gal.	57	2.5	196	695
80-Gal.	71	2.5	224	848

**Table 3: AHRI Certified Water Heater Ratings**

Model	First Hour Rating (Gal/Hr)	Continuous Draw Rating (Gal/Hr)	Standby Heat Loss Rating (°F/Hr)	Minimum Output of Heat Source (BTU/Hr)	Minimum Heat Source Flow Rate (Gal/Min)
40-Gal	110	85	1.1	58,000	8.0
50-Gal	120	85	0.9	58,000	8.0
65-Gal	135	85	0.8	58,000	8.0
80-Gal	145	85	0.6	58,000	8.0

**NOTE:** These certified ratings were obtained with a heat source output and flow rate as specified in Table 3 and a 180°F boiler water supply temperature. Other results will be obtained under different conditions.

**Table 4: Water Heater Performance**

Model	Maximum First Hour Rating (Gal/Hr) @		Continuous Draw Rating (Gal/Min) @		Approximate Boiler Output Needed For Ratings (BTU/hr)
	140°F	115°F	140°F	115°F	
40-Gal.	116	164	1.5	2.3	80,000
50-Gal.	123	171	1.5	2.3	80,000
65-Gal.	132	180	1.5	2.3	80,000
80-Gal.	142	190	1.5	2.3	80,000

**NOTE:** Based on 200°F boiler water temperature and 50°F potable water inlet temperature.



**Table 5: Water Heater Performance**

<b>Model</b>	<b>Hot Water Availability (Minutes)</b>	<b>Coil Heat Transfer Area (Sq Ft)</b>	<b>Pressure Drop at Rated Heat Source Flow Rate (Feet of Head)</b>
<b>40-Gal.</b>	<b>6.8</b>	<b>14.2</b>	<b>2.4</b>
<b>50-Gal.</b>	<b>8.6</b>	<b>14.2</b>	<b>2.4</b>
<b>65-Gal.</b>	<b>10.8</b>	<b>14.2</b>	<b>2.4</b>
<b>80-Gal.</b>	<b>13.5</b>	<b>14.2</b>	<b>2.4</b>

**NOTICE**

If the boiler takes longer to heat up from a cold start than the water availability as noted above, hot water shortage may occur.

Hot water availability is based on drawing 80% of the heated tank volume at 4 gallons per minute flow rate.

The maximum heat transfer through the coil (heat input) of the water heater at 240°F boiler water supply temperature and 210°F potable water temperature is 23,500 Btu/hr. Potable water temperature is limited to below 210 °F and nominal water-containing capacity is below 120 gallons for all indirect-fired models.

Accordingly, per Part HLW-101.2, Section IV of the ASME Boiler and Pressure Vessel Code, all indirect-fired products listed are exempted from compliance with the code.

## **SECTION III GENERAL INFORMATION**

### **FEATURES**

This water heater contains the following features:

**HEAT EXCHANGER** – The heat exchanger (coil) has 3/4” NPT female fittings.

Water heaters with a double-wall heat exchanger meet the Uniform Plumbing Code for installation in all potable water systems. The double-wall construction provides protection in the event that either the potable or hydronic heat exchanger barrier is penetrated. The fluid will move along in integrated leak path within the heat exchanger, leaving the exchanger through a weep hole located in the fittings. If a confirmed leak occurs, contact the plumbing professional who installed the water heater or the manufacturer, listed on the rating plate, for additional guidance.

This indirect-fired water heater is appropriate for all potable heating systems, even where a single-wall exchanger is not approved by the authority having jurisdiction.

**ADJUSTABLE THERMOSTAT** – The temperature may be adjusted from approximately 80°F to approximately 160°F. The thermostat is factory set at 120°F. It is recommended that lower temperatures be used to avoid the risk of scalding. Refer to the “Warnings” and the section on SCALDING in “Section VII – Operating Instructions.” It is further recommended, in all cases, that the water temperature be set for the lowest temperature that satisfies your hot water needs. This will also provide the most energy efficient operation of the water heater and minimizes scale formation.

Setting the water heater temperature at 120°F will reduce the risk of scalds. Some states require settings to specific lower temperatures.

## TEMPERATURE AND PRESSURE RELIEF VALVE

### **WARNING**

**Keep clear of the combination temperature and pressure relief valve discharge line outlet.** The discharge may be hot enough to cause scald injury. The water is under pressure and may splash. For protection against excessive temperatures and pressure, install temperature and pressure protective equipment required by local codes, but not less than a combination temperature and pressure relief valve certified by a nationally recognized testing laboratory that maintains periodic inspection of production of listed equipment or materials as meeting the requirements of the Standard for *Relief Valves and Automatic Gas Shutoff Devices for Hot Water Supply Systems, ANSI Z21.22* and the Standard *CAN1-4.4 Temperature, Pressure, Temperature and Pressure Relief Valves and Vacuum Relief Valves*. The combination temperature and pressure relief valve must be marked with a maximum set pressure not to exceed the maximum working pressure of the water heater. The combination temperature and pressure relief valve must also have an hourly rated temperature steam BTU discharge capacity not less than the hourly rating of the water heater. The supplied combination temperature and pressure relief valve, when properly installed and unrestricted, will discharge the maximum input produced by a 240°F (115°C) boiler supply temperature. A lower boiler supply temperature will reduce the input required to be discharged in the event of excessive potable water temperatures.

Install the combination temperature and pressure relief valve into the opening provided and marked for this purpose on the water heater.

Some models may already be equipped or supplied with a temperature and pressure relief valve. Verify that the combination temperature and pressure relief valve complies with local codes. If the temperature and pressure relief valve does not comply with local codes, replace it with one that does.

## **WARNING**

Install a discharge line so that water discharged from the temperature and pressure relief valve will exit within six (6) inches above, or any distance below, the structural floor and cannot contact any live electrical part. The discharge line is to be installed to allow for complete drainage of both the temperature and pressure relief valve and the discharge line. The discharge opening must not be subjected to blockage or freezing. **DO NOT** thread, plug, or cap the discharge line. It is recommended that a minimum clearance of four (4) inches be provided on the side of the water heater for servicing and maintenance of the combination temperature and pressure relief valve.

**DO NOT** place a valve between the combination temperature and pressure relief valve and the tank!

**SACRIFICIAL ANODES** – Two sacrificial anode rods have been installed in the tank head to extend tank life. The removal of any anodes, except for inspection and/or replacement, will nullify the warranty. The anode rods should be inspected annually to determine the amount of sacrificial decay and replaced when necessary to prolong tank life. Water conditions in your area will influence the time interval for inspection and replacement of the anode rod. The use of a water softener may increase the speed of anode consumption. More frequent inspection of the anode is needed when using softened (or phosphate treated) water. Contact the plumbing professional who installed the water heater or the manufacturer, listed on the rating plate, for anode replacement information.

## **SECTION IV PRE-INSTALLATION**

### **UNPACKING**

**INSPECT SHIPMENT** carefully for any signs of damage. If damage is noted, do not install the product. Contact the shipper or manufacturer. All equipment is carefully manufactured, inspected, and packed. Our responsibility ceases upon delivery of the packaged water heater to the carrier in good condition.

**NOTE:** Any claims for damage or shortage in shipment must be filed immediately against the carrier by the consignee.

This water heater **MUST** be installed indoors out of the wind and weather.

## IMPORTANT DECISIONS REQUIRED BEFORE INSTALLATION

### SIZING

1. **Boiler DOE Heating Capacity** – The indirect-fired water heater will provide the rated performance only if used in conjunction with a heat source with a DOE heating capacity (Heat Output) at least as much as the minimum noted in Table 3. If the heat source has less capacity, the output of the tank will be reduced. To determine the approximate reduction in output from the tank use the following formula:

New Rating = (maximum continuous draw rating) x

$$\frac{\text{Actual Output of Heat Source}}{\text{Minimum Output of Heat Source}}$$

For example, what would the continuous draw rating be if a 50-gallon indirect-fired water heater were installed with a heat source having a DOE heating capacity of 50,000 BTU/h?

**Answer:**

$$\begin{aligned} \text{New Rating} &= 85 \text{ gal/hr} \times (50,000 \text{ BTU/h}) / (58,000 \text{ BTU/h}) \\ &= 85 \text{ gal/hr} \times 0.862 = \mathbf{73 \text{ gal/hr}} \end{aligned}$$

### NOTICE

Increasing the boiler DOE heating capacity above the values listed in Table 3 will not increase the rating of the water heater.

2. **Circulator Sizing** – Refer to Table 5 for the corresponding pressure drop through the coil for the given model. Calculate the pressure drop of all straight pipe and fittings on the supply and return of the water heater at the selected flow rate. Add the piping/fitting pressure drop to the pressure drop through the water heater coil.

Select a circulator that will provide an appropriate flow rate at the combined pressure drop.

## **SYSTEM ZONE CONTROL**

The indirect-fired water heater must be installed as a zone separate from the space heating system. The domestic hot water zone's piping and circulator must be sized for a minimum flow rate with all zones in use and a maximum flow rate with only the water heater in use. For this reason, the preferred method of zone control is with circulators.

1. **Circulators** – With space heating zones using circulators, the indirect-fired heater should be added as an additional zone with a circulator.
2. **Zone Valves** – Select a valve with a low-pressure drop to assure adequate flow through the water heater.
3. **Hybrid** – The space heating zone can be zoned using zone valves and the indirect-fired heater zoned with a circulator.

## **DOMESTIC HOT WATER PRIORITY**

Two options are available, Priority and Non-Priority.

1. **Priority** – Demand for space heating is interrupted or postponed until the domestic hot water demand is satisfied. This option provides maximum delivery of domestic hot water. Priority is recommended when:
  - a) Boiler net output is 100,000 Btu per hour or less, or
  - b) When boiler output required to satisfy domestic hot water demand is at least 50% of the boiler output required to satisfy space heating demand, or
  - c) When an interruption in space heating can be tolerated during a long domestic hot water draw.
2. **Non-Priority** – Boiler output is divided between space heating and domestic hot water heating. Delivery of domestic hot water can be reduced during simultaneous space and domestic hot water heating operations, depending on such factors as boiler output, boiler over-sizing, number of space heating zones calling for heat, and the ratio of domestic hot water load to space heating load.

## COMPONENT LOCATION

### CAUTION

This water heater must be located in an area where leakage of the tank, water line connections, or the temperature and pressure relief valve will not result in damage to the area adjacent to the water heater or to lower floors of the structure. When such locations cannot be avoided, a suitable drain pan must be installed under the water heater. The drain pan depth must be suitable for draining and collecting water. The drain pan can be purchased from your plumbing professional. The drain pan must be piped to an adequate drain. The piping must be at least  $\frac{3}{4}$  inch in diameter and pitched for proper drainage.

Clearance from Combustible Materials			
Top	Sides	Front	Rear
0"	0"	0"	0"

**Table 6 – Combustible Material Clearances**

Recommended Service Clearances			
Non-Piping Side	Front (Thermostat)	Rear	T & P Relief Valve Side
4"	16"	0"	4"

**Table 7 – Service Clearances**

### CAUTION

**DO NOT** drop water heater. **DO NOT** bump water heater jacket against floor.

## APPLIANCE LOCATION

1. **Boiler Location** – Locate the indirect-fired water heater as close to the boiler as practical.
2. **Fixture Locations** – For fastest delivery of hot water, place the indirect-fired water heater close to points of use.

*Pre-installation continued-*

## **ADDITIONAL RECOMMENDED COMPONENTS**

1. **Shut-off Valves** – Allows isolation of water heater from domestic water system and/or boiler system during service.
2. **Unions** – Allows water heater movement during service if adequate clearance cannot be provided.
3. **Thermal Expansion Tank** – If the water heater is installed in a closed water supply system, such as one having a back-flow preventer in the cold water line, provide thermal expansion control. Contact the water supplier or local plumbing inspector for additional information.

### **WARNING**

DO NOT plug the inlet and outlet tapings of tankless heater left installed in the boiler.

**MOVE THE WATER HEATER TO A PERMANENT POSITION BY SLIDING OR WALKING.**

### **NOTICE**

For California installation this water heater must be braced, anchored, or strapped to avoid falling or moving during an earthquake. See instructions for correct installation procedures. Instructions may be obtained from California Office of the State Architect, 400 P Street, Sacramento, CA 95814.



## SECTION V WATER CONNECTIONS

### **WARNING**

**FAILURE TO INSTALL AND MAINTAIN A NEW, LISTED TEMPERATURE AND PRESSURE RELIEF VALVE WILL RELEASE THE MANUFACTURER FROM ANY CLAIM WHICH MIGHT RESULT FROM EXCESSIVE TEMPERATURE AND PRESSURES.**

Hydrogen gas can be produced in an operating water heater that has not had water drawn from the tank for a long period of time. **HYDROGEN GAS IS EXTREMELY FLAMMABLE.** To prevent the possibility of injury under these conditions, we recommend the hot water faucet be opened for several minutes at the kitchen sink before you use any electrical appliance that is connected to the hot water system. If hydrogen is present, there will be an unusual sound such as air escaping through the pipes as hot water begins to flow. **DO NOT** smoke or have open flame near the faucet at the time it is open.

Keep clear of the temperature and pressure relief valve discharge line outlet. The discharge may be hot enough to cause scald injury. The water is under pressure and may splash.

### **CAUTION**

If sweat fittings are to be used, **DO NOT** apply heat to the nipples on top of the water heater. Sweat the tubing to the adapter before fitting the adapter to the water connections. It is imperative that heat is not applied to the nipples containing a plastic liner.

## **INSTALL TEMPERATURE AND PRESSURE RELIEF VALVE** (if not factory installed)

### **WARNING**

Temperature and pressure relief valve discharge piping must be piped near the floor to eliminate potential of severe burns. **DO NOT** pipe in any area where freezing could occur. **DO NOT** install any shut-off valves, plugs or caps to the temperature and pressure relief valve or piping.

## **INSTRUCTIONS FOR POTABLE CONNECTIONS**

1. **BEFORE PROCEEDING WITH THE INSTALLATION, CLOSE THE MAIN WATER SUPPLY VALVE.** After shutting off the main water supply, open a faucet to relieve the water line pressure to prevent any water from leaking out of the pipes while making the water connections to the water heater. After the pressure has been relieved, close the faucet. The **COLD** water inlet and **HOT** water outlet are identified on the top of the water heater. Make the proper plumbing connections between the water heater and the plumbing system to the house. Install a shut-off valve in the cold water supply line.
2. If this water heater is installed in a closed water supply system, such as one having a back-flow preventer in the cold water supply, provisions must be made to control thermal expansion. **DO NOT** operate this water heater in a closed system without provisions for controlling thermal expansion. Warranties do not cover damages from thermal expansions such as pressure bulges and/or deformities. A properly sized expansion tank will alleviate most problems. Your water supplier or local plumbing inspector should be contacted on how to control this situation.
3. After installation of the water lines, open the main water supply valve and fill the water heater. While the water heater is filling, open several hot water faucets to allow air to escape from the water system. When steady streams of water flow through the faucets, close them and check all water connections for possible leaks.
4. **NEVER OPERATE THE WATER HEATER WITHOUT FIRST BEING CERTAIN THAT IT IS FILLED WITH WATER.**

## INSTRUCTIONS FOR BOILER CONNECTIONS

The indirect-fired heater connection labeled "To Boiler Return" should be piped to the boiler return piping as close to the boiler as possible and especially after any flow control or check valves in the space heating return piping. The use of a union and a shut-off valve is recommended. The use of a flow control or check valve is required to prevent back flow through the water heater during operation of the space heating system. Pipe and fittings between the boiler and indirect-fired water heater should be  $\frac{3}{4}$ " diameter or larger.

## CONNECT WATER BOILER SUPPLY PIPING

1. For a space heating system that utilizes ZONE VALVES, refer to Figure 2. The indirect-fired water heater connection labeled "FROM BOILER SUPPLY" should be piped to the boiler supply piping. Mount the circulator making sure the flow arrow points toward the water heater. The use of shut-off valves and unions are recommended for future service convenience. The use of an air separator and vent is recommended to eliminate air in the system. Pipe and fittings between the boiler and indirect-fired water heater must be  $\frac{3}{4}$ " diameter or larger.

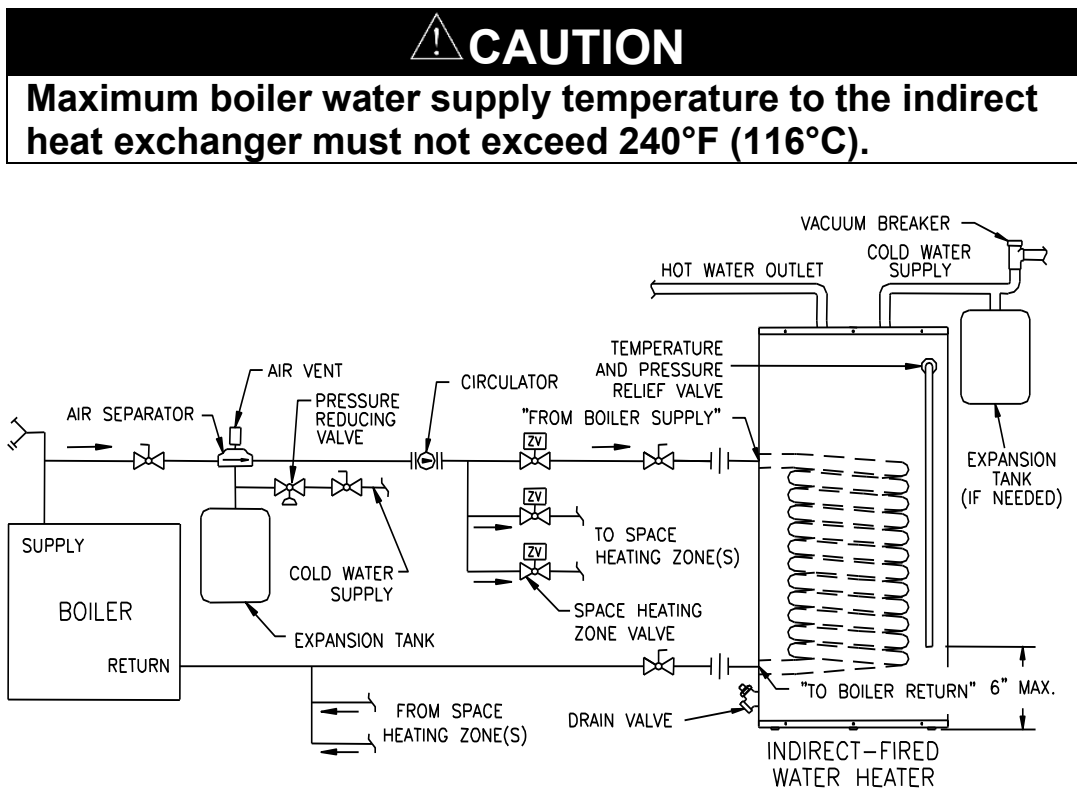
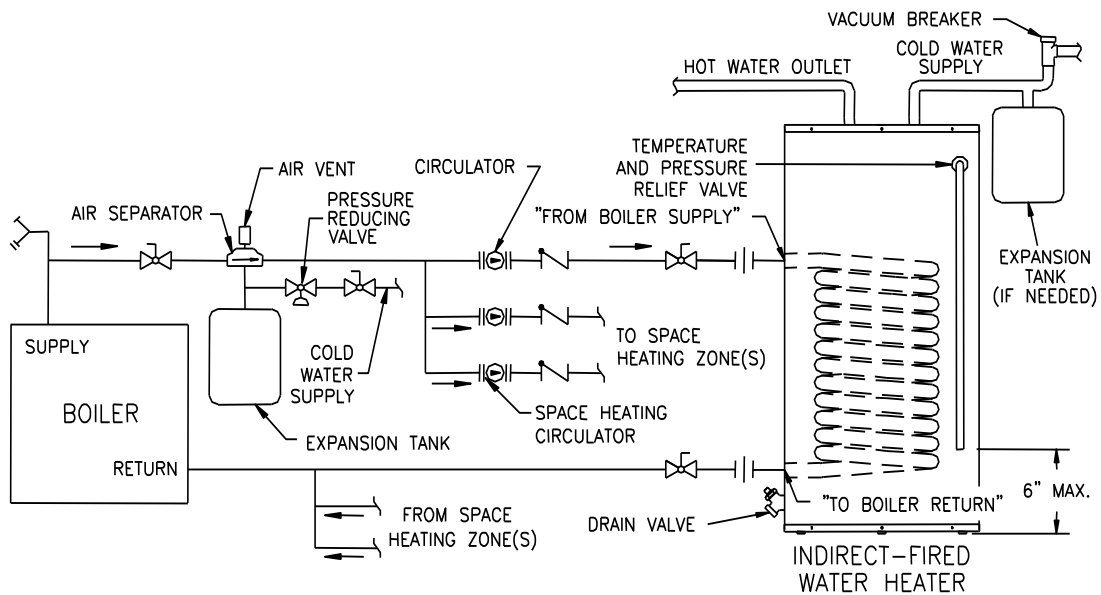

Figure 2 - Water Boiler Piping with Zone Valves

**Water Connections continued-**

2. For a space heating system that utilizes CIRCULATORS, refer to Figure 3. The indirect-fired water heater connection labeled "FROM BOILER SUPPLY" should be piped to the boiler supply piping. Mount the circulator making sure the flow arrow points toward the water heater. The use of shut-off valves and unions are recommended for future service convenience. The use of an air separator and vent is recommended to eliminate air in the system. Pipe and fittings between the boiler and indirect-fired water heater must be  $\frac{3}{4}$ " diameter or larger.



**Figure 3 - Water Boiler Piping with Circulators**

**CONNECT STEAM BOILER SUPPLY PIPING**

Figure 4 represents a typical steam boiler connection diagram. Refer to the boiler installation manual or contact the boiler manufacturer for an appropriate piping diagram. The use of a union, shut-off valves, and a drain valve is recommended for future service convenience. The use of an in-line "Y"-style strainer is required to prevent accumulation of sludge in the water heater's coil.



## **SECTION VI ELECTRICAL CONNECTIONS**

Install electric wiring in accordance with National Electric Code or the Canadian Electrical Code and local regulations. See the boiler's installation manual for wiring diagrams.

### **DANGER**

Positively assure all electrical connections are unpowered before attempting installation or service of electrical components or connections of the water heater or building. Lock out all electrical boxes with padlock once power is turned OFF.

### **WARNING**

When installed, the water heater must be electrically grounded in accordance with local codes or, in the absence of local codes, with the National Electrical Code, ANSI/NFPA 70, and /or the CSA C22.1 Electric Code.

Failure to properly wire electrical connections to the water heater may result in serious physical harm.

Electrical power may be from more than one source. Make sure all power is off before attempting any electrical work.

The thermostat incorporates a manual reset temperature-limiting device. Please refer to the TROUBLESHOOTING GUIDE section for manual reset operation.

The thermostat incorporates a manual adjustable temperature indicator to change the potable water temperature. Please refer to WATER TEMPERATURE ADJUSTMENT in the OPERATING INSTRUCTIONS section for proper instruction in adjusting water temperature. Turn OFF all power related to the boiler and heating system before proceeding with the electrical connections.

The thermostat switch is a single pole, single throw device. The field connections shall be used as a control for one leg of the electrical circuit. The thermostat switch can be used in the range of 24 to 480 volts with a maximum current load of 15 amps. Any and all wiring shall be sized and installed to satisfy the voltage and amperage used. All wiring shall be done in accordance with all applicable local and state codes.

## **GENERAL INSTALLATIONS**

If a circulator is used to control the heating fluid flow from the water heater to the boiler, a zone relay is required between the water heater thermostat and the boiler. Connect the white wire on the water heater to one leg of the circulator. The second leg of the circulator is to be connected to “L2” (120V neutral). Connect the white wire on the water heater to one leg of the zone relay. The second leg of the zone relay is to be connected to “L2” (120V neutral). The contact side of the zone relay is to be connected to the boiler operating control (see figure 5). Connect the black wire on the water heater to “L1” (120V hot). These connections enable water heater thermostat to control the circulator, the zone relay, and the boiler operating control.

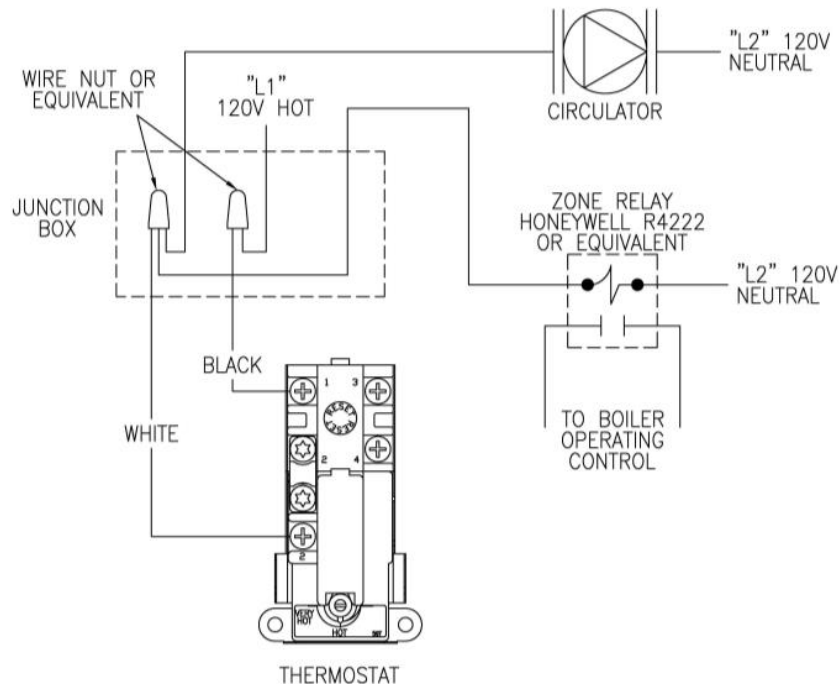

**Figure 5 – Electrical Connection with Circulator**

If a zone valve is used to control the heating fluid flow from the boiler to the water heater, a zone step-down transformer is required between the water heater thermostat and the zone valve. Connect the white wire on the water heater to one leg of the transformer primary side. The second leg of the primary side is to be connected to “L2” (120V neutral). The secondary side of the transformer is to be connected to the zone valve coil. The contact side of the zone valve is to be connected to the boiler operating control. Connect the black wire on the water heater to “L1” (120V hot) (see figure 6). These connections enable the water heater thermostat to control the zone valve and the boiler operating control.

**Electrical Connections continued-**

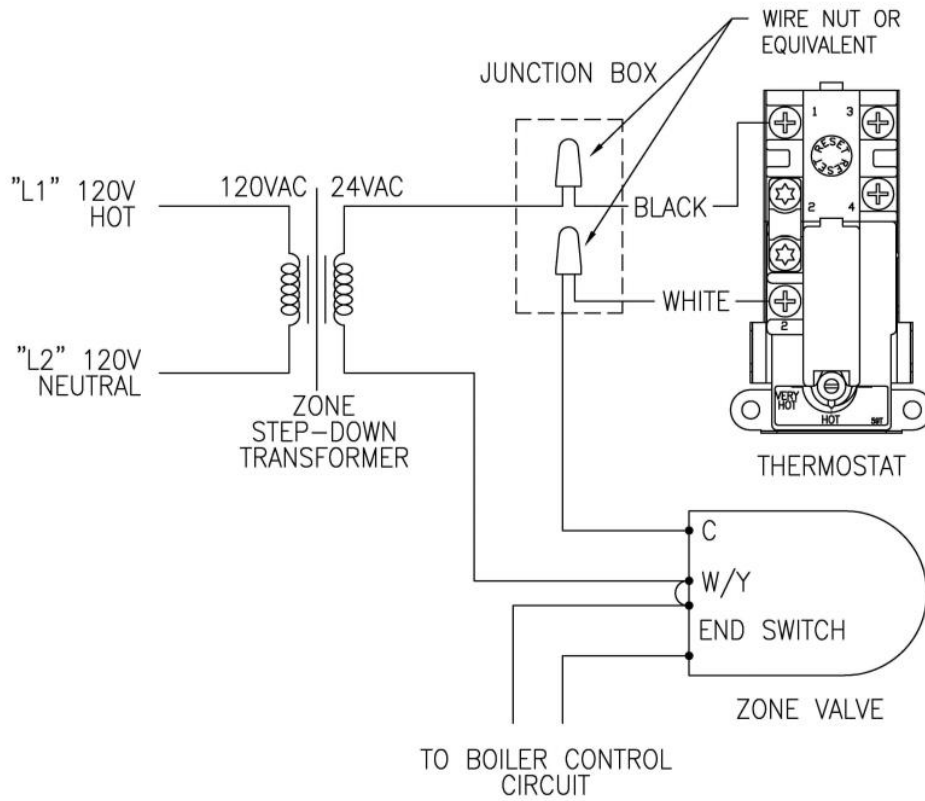

**Figure 6 – Electrical Connection with Zone Valve**

Other installations may require slightly different wiring arrangements. In all cases it is important to remember that the thermostat on the water heater only controls one leg of the system.



## SECTION VII OPERATING INSTRUCTIONS

### **WARNING**

Water heaters are heat-producing appliances. To avoid damage or injury there must be no materials stored against the water heater, and proper care must be taken to avoid unnecessary contact (especially by children) with the water heater. **UNDER NO CIRCUMSTANCES SHALL FLAMMABLE MATERIALS, SUCH AS GASOLINE OR PAINT THINNER BE USED OR STORED IN THE VICINITY OF THE WATER HEATER OR IN ANY LOCATION FROM WHICH FUMES COULD REACH THE WATER HEATER.**

Installation or service of this water heater requires ability equivalent to that of a licensed tradesman in the field involved. Plumbing and electrical work are required.

### **SYSTEM START-UP**

Follow boiler installation instructions to place boiler in operation.

### **SEQUENCE OF OPERATIONS**

1. Thermostat senses stored water temperature drops below desired setting.
  - a. *Domestic hot water priority only: Normally closed contacts open to interrupt space heating.*
2. Thermostat satisfied.
  - a. Thermostat contacts open, turning off domestic hot water circulator and de-energizing relay.
  - b. Normally open contacts open, stopping boiler operation.
  - c. *Domestic hot water priority only: Normally closed contacts close, returning boiler control to space heating.*

**⚠ WARNING**  
**SCALDING**

This water heater can deliver scalding temperature water at any faucet in the system. Be careful whenever using hot water to avoid scalding injury. By setting the thermostat on this water heater to obtain an increased water temperature, you may create the potential for scald injury. To protect against injury, you should install an ASSE approved mixing valve (a device to limit the temperature of water to protect against scald injury via mixing hot and cold water supply) in the water system. This valve will reduce point of discharge temperature in branch supply lines. Such valves are available from the manufacturer of this water heater or a local plumbing supplier. Please consult with a plumbing professional.

Table 8 details the approximate relationship of water temperature and time with regard to scald injury and may be used as a guide in determining the safest water temperature for your applications.

**⚠ DANGER**



Water temperature over 125°F can cause severe burns instantly or death from scalds.  
Children, disabled and elderly are at highest risk of being scalded.  
Review this instruction manual before setting temperature at water heater.  
Feel water before bathing or showering.  
Temperature limiting valves are available.

<b>APPROXIMATE TIME/TEMPERATURE RELATIONSHIPS IN SCALDS</b>	
120°F	More than 5 minutes
125°F	1 ½ to 2 minutes
130°F	About 30 seconds
135°F	About 10 seconds
140°F	Less than 5 seconds
145°F	Less than 3 seconds
150°F	About 1 ½ seconds
155°F	About 1 second

**Table 8 – Scald Relationships**

**Figure 7 - Scald Warning**

## ⚠ CAUTION

Before adjusting the thermostat, turn off all power supplied to the indirect-fired water heater.

The potable water temperature can be changed by adjusting the thermostat. Before any work is done on the water heater, disconnect all power to the water heater and heat source (boiler) by opening the switch(s) at the main electrical circuit breaker or fuse box. Remove the access panel and fold the insulation outward away from the control. Adjust the thermostat dial using a screwdriver until the minimum acceptable temperature is achieved. The thermostat has been factory preset to 120°F (49°C). **Remember that lower temperature settings are more energy efficient.** Rotate the temperature dial **clockwise** ↻ to increase water temperature. Rotate the thermostat dial **counter-clockwise** ↻ to decrease the temperature setting. Replace the insulation making sure that the control is well covered and that the plastic terminal shield has not been displaced. Replace the access panel. The water heater is now ready for operation and the main switch can be closed.

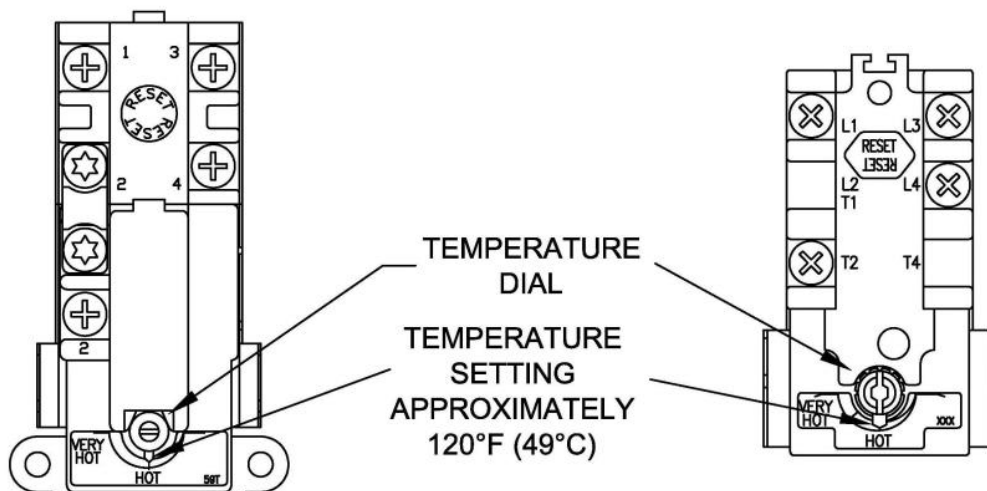

**Figure 8 – Thermostat**

After the indirect-fired water heater completes a heat-up cycle, check the water temperature at a faucet. Allow enough water to flow to ensure that the water temperature reflects the tank temperature. Adjust the water heater's temperature setting as necessary.

*Operating Instructions continued-*

Adjusting to a lower temperature setting will not immediately affect water temperature. Draw sufficient water or allow the water heater to remain idle until a heat-up cycle is initiated. After the heater's heat-up cycle is complete, check the water temperature at a faucet to determine if further adjustment is necessary.

Adjusting to a higher temperature may not immediately affect water temperature. If a heat-up cycle begins, allow the heat-up cycle to complete before checking the water temperature. If a heat-up cycle does not begin, draw sufficient water or allow the water heater to remain idle until a heat-up cycle is initiated. After the heater's heat-up cycle is complete, check the water temperature at a faucet to determine if further adjustment is necessary.

## **SECTION VIII MAINTENANCE**

This indirect-fired water heater is intended to provide a service life of many years. Components that require service, however, may be subject to failure. Failure to use the correct procedures or parts in these circumstances may make the water heater unsafe.

The owner should arrange to have the following inspections and simple maintenance procedure performed by qualified service personnel at the frequencies suggested.

1. ***Boiler and Domestic Water Piping (Annual)*** – Check all piping for signs of leakage at joints, unions, and shut-off valves. Repair as needed.
2. ***Temperature-Pressure Relief Valve (Annual)***- The temperature-pressure relief valve should be checked to ensure that it is in operating condition. To check the relief valve, lift the lever at the end of the valve several times. The valve should seat properly and operate freely. If water does not flow, remove and inspect for obstructions or corrosion. Replace with a new valve of the recommended capacity as necessary. Do not attempt to repair the valve, as this could result in improper operation and a tank explosion. In areas with poor water conditions, it may be necessary to inspect the temperature-pressure relief valve more often than once a year.

 **CAUTION**

Before manually operating the valve, make sure that a drain line has been attached to the valve to direct the discharge to an open drain. Failure to take this precaution could mean contact with extremely hot water discharging from the valve during this checking operation.

If the temperature–pressure relief valve on the heater discharges periodically or continuously, it may be due to thermal expansion of water in a closed water supply system, or it may be due to a faulty relief valve.

Thermal expansion is the normal response of water when it is heated. In a closed system, thermal expansion will cause the system pressure to build until the relief valve actuation pressure is equaled. Then the relief valve will open, allowing some water to escape, slightly lowering the pressure. Contact your water supplier or local plumbing inspector on how to control this situation.

**ABOVE ALL, DO NOT PLUG THE TEMPERATURE AND PRESSURE RELIEF VALVE. THIS IS NOT A SOLUTION AND CAN CREATE A HAZARDOUS SITUATION.**

3. ***Anode Inspection and Replacement*** - This water heater is equipped with multiple sacrificial anodes. Anodes protect the glass-lined tank from corrosion by sacrificing themselves through electrolysis. When the anode material is consumed, there is no more protection and corrosion of the tank accelerates.

Inspection of the anode every year allows you to identify a spent anode and replace. Replace the anode when its diameter is 3/8 of an inch, or every other year, whichever is first. Aggressive, very hot and softened water causes rapid consumption of the anode, requiring frequent inspections. Anodes are available from your distributor or from the manufacturer.

#### 4. **To inspect or replace an anode:**

The anodes on this water heater are easily accessible from the top of the heater making replacement simple and quick.

- a. Turn the water heater electricity off for the zone containing the indirect-fired water heater. Flow water until the discharge is cool or allow enough time for the potable water to cool naturally. Connect a hose to the drain valve. Locate the hose's discharge in an area where any remaining hot water will not cause any damage or injury.
  - b. Open the drain valve to flush any sediment out of the bottom to the heater.
  - c. Shut off the cold water supply. Make sure all hot water fixtures and circulating pumps are turned off.
  - d. Wait for water flow from the hose to stop. Remove the anode using a socket of the appropriate size. Do not use an impact wrench.
  - e. Inspect and replace the anode as required. Use pipe tape or sealant when reinstalling the anode.
  - f. Close the drain valve. Open a hot water fixture to allow air to escape. Open the cold water supply to the heater and allow the tank to fill.
  - g. Check your anode and drain valve for leaks.
  - h. Turn the water heater electricity on for the zone containing the indirect-fired water heater.
5. ***Sediment (Annual, but harsh water quality may dictate more frequent service)***- Depending on water conditions, a varying amount of sediment may collect in the tank. Levels requiring service are indicated by a small temperature difference in the supply and return lines (See also "Scale" below). Repeated flushing usually clears such material. As a preventive measure, water should be drawn from the tank at the drain valve until it runs clear.
6. ***Scale (Annual)***- Hard water may cause scale to build-up on the outside of the heat exchanger coil. A water softener will prevent this problem (See also "Sediment" above). Symptoms would be reduced recovery capacity or reduced temperature differential between boiler supply and return lines. Repeated flushing should resolve the problem.

## SECTION IX TROUBLESHOOTING GUIDE

PROBLEM	CAUSE	SOLUTION
No hot water at faucet	Boiler does not operate	Refer to boiler installation instructions
		Check main service switch
		Check fused disconnect
	Circulator does not operate	Check power supply
		Replace as necessary
	Temperature high limit on thermostat tripped	Determine reason for trip. Depress red "RESET" button on thermostat
	Improper thermostat setting or calibration	Adjust tank thermostat to appropriate setting. See Section VII
	Zone valve does not open (if used)	Check power supply
		Replace as necessary
	Electrical problem (relay, wiring, etc.)	Check fuse and replace
Check circuit breaker and reset (if applicable)		
Check power supply		
Scale build-up	If boiler, circulator, and tank are operating satisfactorily, coil may have scale coating. See Section VIII: Maintenance	
Clogged cold water filter or boiler supply strainer (if used)	Clean or replace filter or strainer	
Water at faucet too hot	Thermostat set too high	Adjust thermostat setting. See Section VII
	Improper system plumbing	Compare plumbing to Section V
	Improper system wiring	Compare wiring to Section VI

*Troubleshooting Guide continued-*

<b>PROBLEM</b>	<b>CAUSE</b>	<b>SOLUTION</b>
Insufficient hot water	Thermostat setting too low	Adjust thermostat to higher setting. See Section VII
	Undersized boiler with no priority to domestic hot water	Rewire for priority
	Peak use of hot water is greater than tank storage capacity	Determine peak usage and compare to tank capacity
	Faulty tank thermostat	Replace thermostat
Boiler cycles more than 5 times per day in summer	Excessive demand	Reduce demand or consider larger tank
	Faulty thermostat	Replace thermostat
	Boiler high limit set too low	Increase boiler high limit setting



## SECTION X PARTS LIST

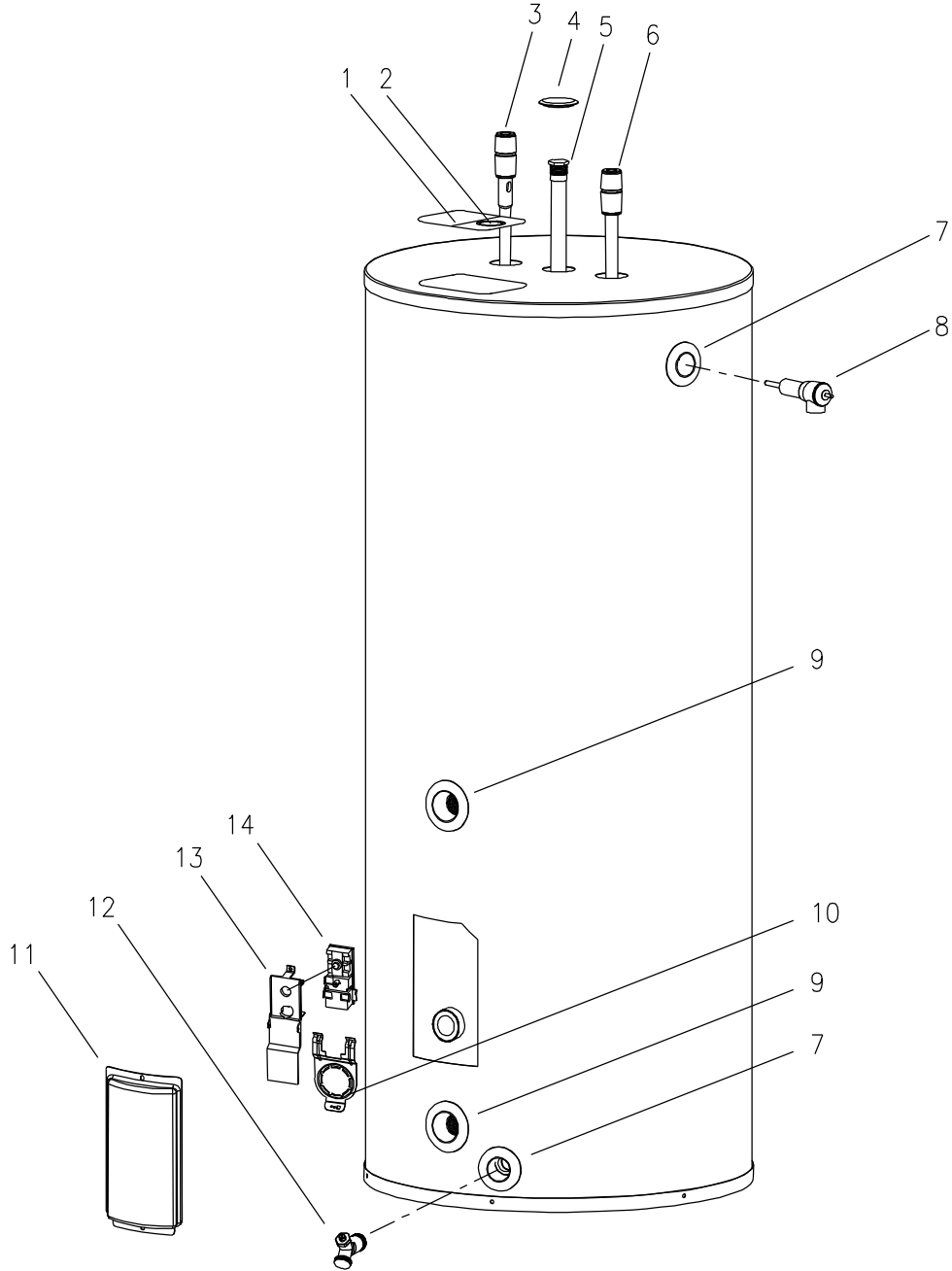

<b>PART NAME &amp; DESCRIPTION</b>	
1. Electrical Outlet Cover	8. T&P Relief Valve
2. Conduit Grounding Cover	9. Heat Exchanger Escutcheon
3. Outlet Anode Device	10. Thermostat Bracket
4. Hole Closure	11. Access Cover
5. Hex Head Anode	12. Drain Valve
6. Inlet Diptube	13. Thermostat Protector
7. Escutcheon	14. Thermostat

Contact your supplier or plumbing professional for replacement parts or contact the company at the address given on the rating plate of the water heater. Provide the part name, model, and serial numbers of the water heater when ordering parts.

**READ THE WARRANTY FOR A FULL EXPLANATION OF THE LENGTH OF TIME THAT PARTS AND THE WATER HEATER ARE WARRANTED.**

Manufactured under one or more of the following U.S. Patents: 5,277,171; 5,341,770; 5,372,185; 5,485,879; 5,574,822; 5,596,952; 5,660,165; 5,682,666; 5,761,379; 5,943,984; 5,954,492; 5,988,117; 6,056,542; 6,142,216; 6,442,178; 6,684,821; 6,935,280; 7,063,132; 7,063,133; 7,007,748; 7,270,087; 7,334,419; 7,337,517; 7,409,925; 7,458,341; 7,559,293; 7,621,238; 7,634,976; 7,650,859; 7,665,210; 7,665,211; 7,699,026; 7,866,168; 7,900,589; 7,971,560; 7,992,526 8,082,888; 8,146,772; Other U.S. and Foreign patent applications pending.  
Current Canadian Patents: 2,092,105; 2,107,012; 2,108,186; 2,112,515; 2,143,031; 2,239,007; 2,262,174; 2,314,845; 2,409,271; 2,476,685; 2,504,824; 2,548,958

Complete the following information and retain for future reference:

Model No: \_\_\_\_\_

Serial No: \_\_\_\_\_

Service Phone

Days: \_\_\_\_\_ Nights: \_\_\_\_\_

Address: \_\_\_\_\_

Supplier: \_\_\_\_\_

Supplier Phone No: \_\_\_\_\_

**NOTES**

This page intentionally left blank.

# Double-Wall Indirect-Fired WATER HEATER

A Spanish language version of these instructions is available by contacting the manufacturer listed on the rating plate.

La version espanola de estas instrucciones se puede obtener al escribirle a la fábrica cuyo nombre aparece in la placa de especificaciones.

*Laars Heating Systems Company reserves the right to change specifications, components, features, or to discontinue products without notice.*



**Customer Service and Product Support: 800.900.9276 • Fax 800.559.1583**  
**Headquarters: 20 Industrial Way, Rochester, NH 03867 • 603.335.6300 • Fax 603.335.3355**  
9 Brigden Gate, Halton Hills, Ontario, Canada L7G 0A3 • 905.203.0600 • Fax 905.636.0666  
**[www.Laars.com](http://www.Laars.com)**

Litho in U.S.A. © Laars Heating Systems 21-04 Document 11064F